

Encoder Signal Conditioner

EC-LV

- In-line signal conditioner
- Frequency to voltage converter
- Angular position 0-360°
- Angular velocity
- Externally adjustable full-scale RPM and direction



Description

The *EC-LV* is an encoder signal conditioner, which can be used to convert the digital pulses of the *Wheel Pulse Transducer (WPT)* or some slip ring assemblies with built in encoders into linear voltages. In addition to the standard encoder outputs (A, B, I, A⊕B), the *EC-LV* outputs both a voltage proportional to angular velocity and a voltage proportional to the angular position from 0 to 360°. Rotational direction and speed range are externally adjustable via toggle switches. The *EC-LV* comes with two pre-set speed ranges, and these can be adjusted on special request. This signal conditioner is added in-line with the encoder cable so there is no need for post processing or an additional power supply.

Specifications

Electrical Specifications	
Input Voltage	+5 to +20 Vdc
Maximum Input Current	270 mA
Output Type (Angular Position)	0-10 Vdc
Output Type (Angular Velocity)	±10 Vdc
Output Type (Sine-Cosine)	10 V peak-to-peak
Reverse Voltage Protection	20 Vdc
Mechanical Specifications	
Size (W x D x H)	5.6 x 3.7 x 2.2 in [142 x 94 x 56 mm]
Weight	12.4 oz [351 g]
Temperature Range	-40 °F to 212 °F [-40 °C to 100 °C]
Protection Rating	IP40

Encoder Signal Conditioner

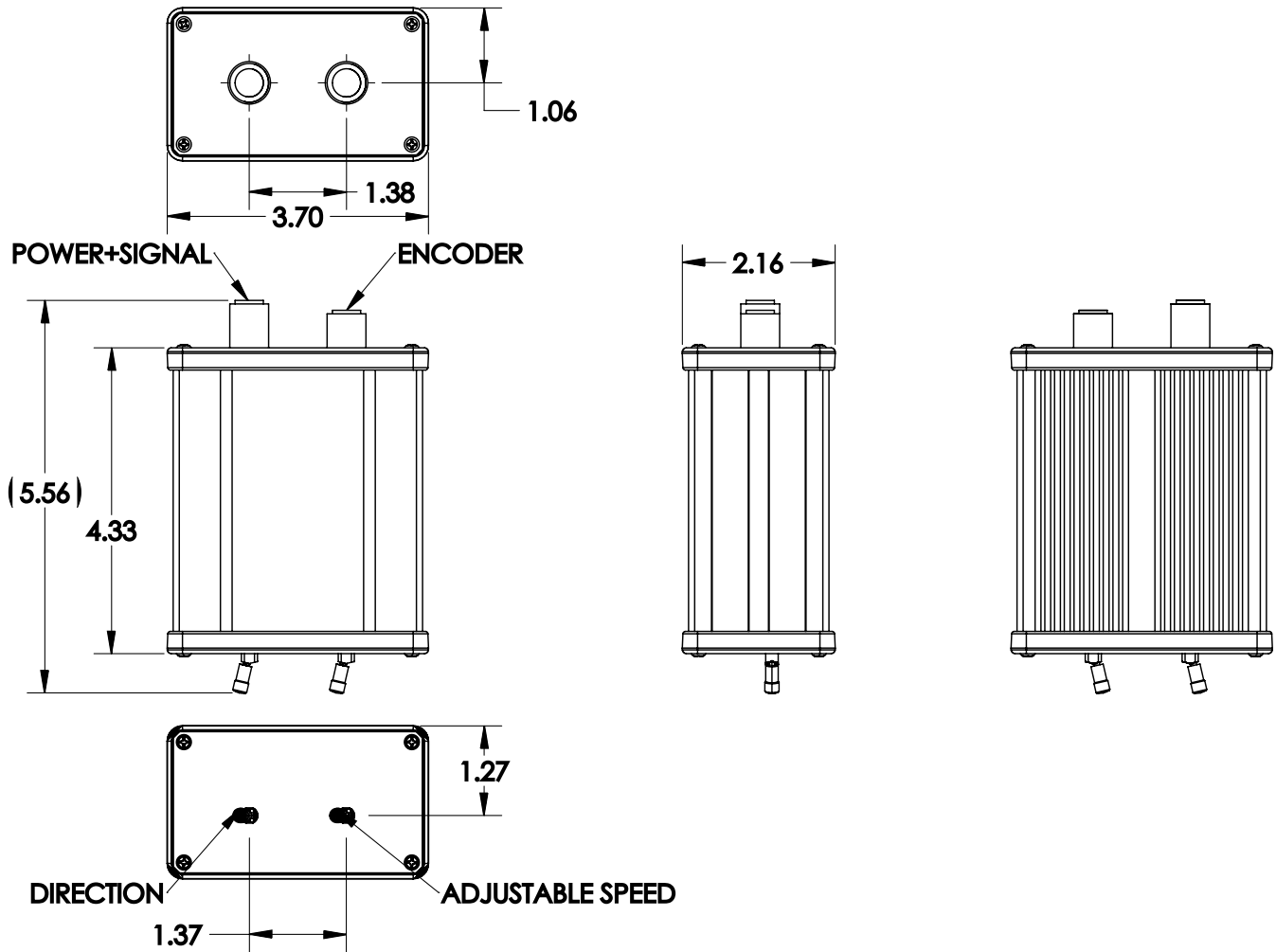

8500 Ance Road
 Charlevoix, MI 49720
 Tel: 231-547-5511
 Fax: 231-547-7070
 01-5-22
 Rev. A

MICHIGAN SCIENTIFIC
 corporation
<http://www.michsci.com>
 Email: miscinfo@michsci.com

321 East Huron Street
 Milford, MI 48381
 Tel: 248-685-3939
 Fax: 248-685-5406